



Precision Digital Corporation

233 South Street
 Hopkinton MA 01748
 Phone (508) 655 - 7300
 Email sales@predig.com



www.predig.com

Part Number	PDEA-A5PVA6-PL-1F00RH-0-0		
Manufacturer	Precision Digital Corporation	Feed-In Voltage	120VAC
Project Description	Process Value Alarm	Control Voltage	120VAC
Type	Standard Product	Environmental Rating	UL Type 4X
Regulation	UL508A	Short Circuit Current Rating	N/A
Created on	04/13/26		
Edit date	06/12/26	by: SLEONARD	Number of pages 12

Creation Date 04/13/26	Creator Name SLEONARD	Specifications: UL508A LISTED CONTROL PANEL Class 1 Control Circuit Incoming Power: 120 VAC 50/60 HZ, 5A Fuse Spec: UL Listed 125/250 VAC 5A Circuit Breaker Spec: UL Listed 240 VAC/48 VDC, 10A, 1-pole, C curve	Installation Requirements: Use only Copper Conductors rated 250V min, 60°C min. Tighten Fuse Terminals to 7 in-lbs. Tighten Circuit Breaker Terminals to 21 in-lbs. Tighten GND and N Terminal Blocks to 4.4 in-lbs. Tighten all other Field Terminals to 3.5 in-lbs. Use conduit hubs or fittings with the same environmental rating as the enclosure.	Notes:		Project Name PDEA-A5PVA6-PL-1F00RH-0-0 233 South Street Hopkinton, MA 01748 Phone: (508) 655-7300 www.predig.com	Project Description Process Value Alarm	Document Type Title page / cover sheet	Section Page NO. 1 of 2		
Mod. Date 05/29/26	Mod. Name SLEONARD					Drawing Number DWG-PDEA-A5PVA6-PL-1F00RH-0-0	UL Requirement UL508A	Scale 1 : 1	Page Title: Title Page	Project Sheet NO. 1 of 12	REV. B

Table of Contents

Precision Digital Corporation

233 South Street
Hopkinton MA, 01748

Page	Page Description	Date	Edited By
1	Title Page	05/29/26	SLEONARD
2	Table of Contents	06/12/26	SLEONARD
Electrical Schematic			
3	Internal Panel Wiring	05/29/26	SLEONARD
4	Internal Panel Wiring	05/29/26	SLEONARD
5	Internal Panel Wiring	05/29/26	SLEONARD
Panel Layout			
6	Subpanel Layout	05/29/26	SLEONARD
7	External Enclosure Layout	06/12/26	SLEONARD
Bill of Materials			
8	Summarized Parts List	05/28/26	SLEONARD
9	Summarized Parts List	05/29/26	SLEONARD
10	Summarized Parts List	05/29/26	SLEONARD
11	Summarized Parts List	05/29/26	SLEONARD
12	Summarized Parts List	05/29/26	SLEONARD

Creation Date 04/13/26	Creator Name SLEONARD	Specifications: UL508A LISTED CONTROL PANEL Class 1 Control Circuit Incoming Power: 120 VAC 50/60 HZ, 5A Fuse Spec: UL Listed 125/250 VAC 5A Circuit Breaker Spec: UL Listed 240 VAC/48 VDC, 10A, 1-pole, C curve	Installation Requirements: Use only Copper Conductors rated 250V min, 60°C min. Tighten Fuse Terminals to 7 in.-lbs. Tighten Circuit Breaker Terminals to 21 in.-lbs. Tighten GND and N Terminal Blocks to 4.4 in.-lbs. Tighten all other Field Terminals to 3.5 in.-lbs. Use conduit hubs or fittings with the same environmental rating as the enclosure.	Notes:	 <p>233 South Street Hopkinton, MA 01748 Phone: (508) 655-7300 www.predig.com</p>	Project Name PDEA-A5PVA6-PL-1F00RH-0-0	Project Description Process Value Alarm	Document Type Table of contents	Section Page NO. 2 of 2	
Mod. Date 06/12/26	Mod. Name SLEONARD					Drawing Number DWG-PDEA-A5PVA6-PL-1F00RH-0-0	UL Requirement UL508A	Scale 1 : 1	Page Title: Table of Contents	Project Sheet NO. 2 of 12

PANEL TO BEAR
UL508A LABEL

 UL508A LISTED CONTROL PANEL

NOTE:
Specifications:
Class 1 Control Circuit
Incoming Power: 120 VAC 50/60 HZ, 5A
Fuse Spec: UL Listed 125/250 VAC 5A
Circuit Breaker Spec:
UL Listed 240 VAC/48 VDC, 10A, 1-pole, C curve

Installation Requirements:
Use only Copper Conductors rated 250V min, 60°C min.
Tighten Fuse Terminals to 7 in-lbs.
Tighten Circuit Breaker Terminals to 21 in-lbs.
Tighten GND and N Terminal Blocks to 4.4 in-lbs.
Tighten all other Field Terminals to 3.5 in-lbs.
Use conduit hubs or fittings with the same environmental rating as the enclosure.

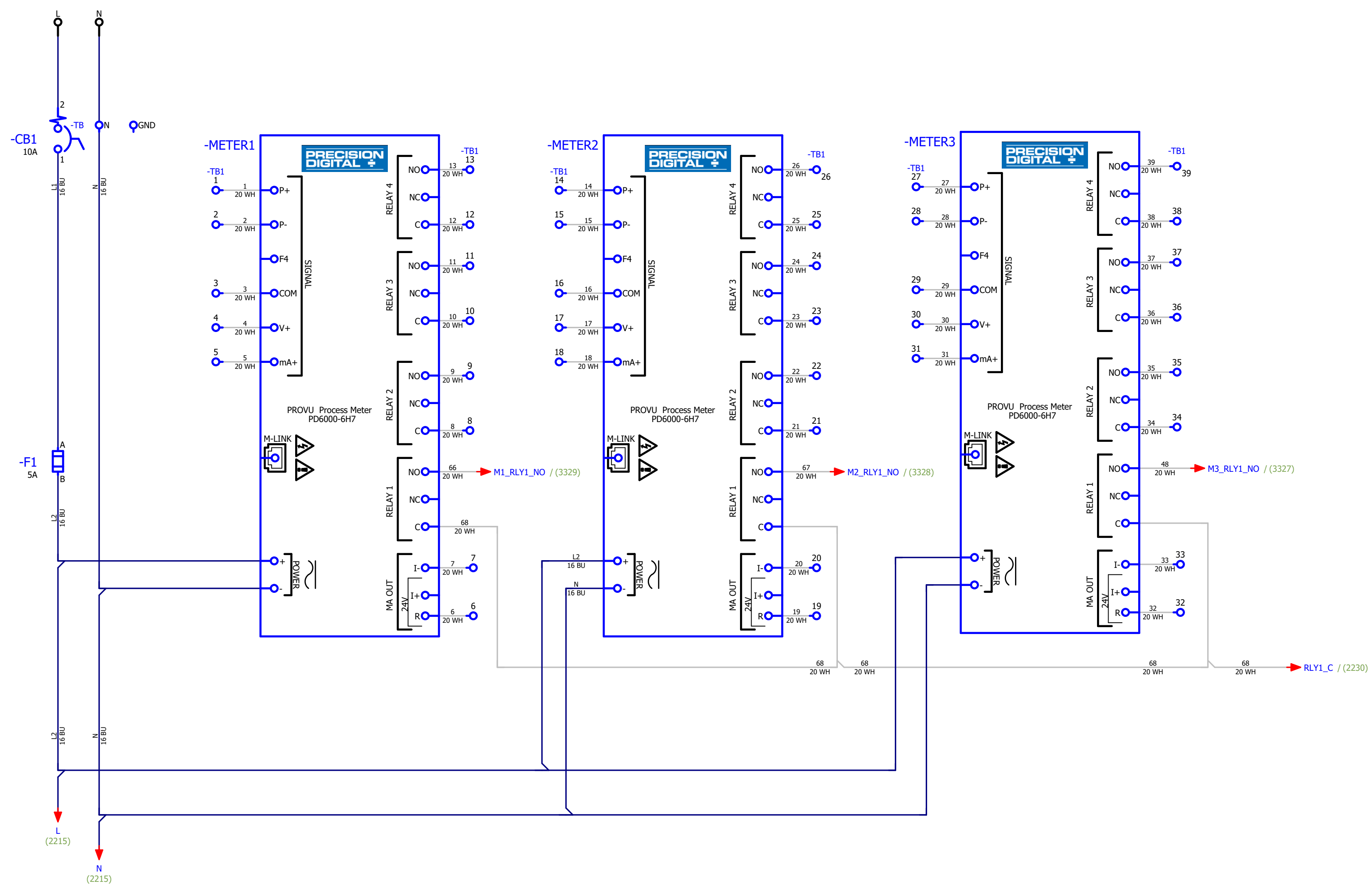

109
110
111
112
113
114
115
116
117
118
119
120
121
122
123
124
125
126
127
128
129
130
131
132
133
134
135
136
137
138
139

Creation Date 04/13/26	Creator Name SLEONARD		Project Name PDEA-A5PVA6-PL-1F00RH-0-0	Project Description Process Value Alarm		Document Type Schematic multi-line		Section Page NO. 1 of 3	
Mod. Date 05/29/26	Mod. Name SLEONARD		Drawing Number DWG-PDEA-A5PVA6-PL-1F00RH-0-0	UL Requirement UL508A	Scale 2 : 3	Page Title: Internal Panel Wiring		Project Sheet NO. 3 of 12	REV. B
			233 South Street Hopkinton, MA 01748 Phone: (508) 655-7300 www.predig.com						

NOTES

209
210
211
212
213
214
215
216
217
218
219
220
221
222
223
224
225
226
227
228
229
230
231
232
233
234
235
236
237
238
239

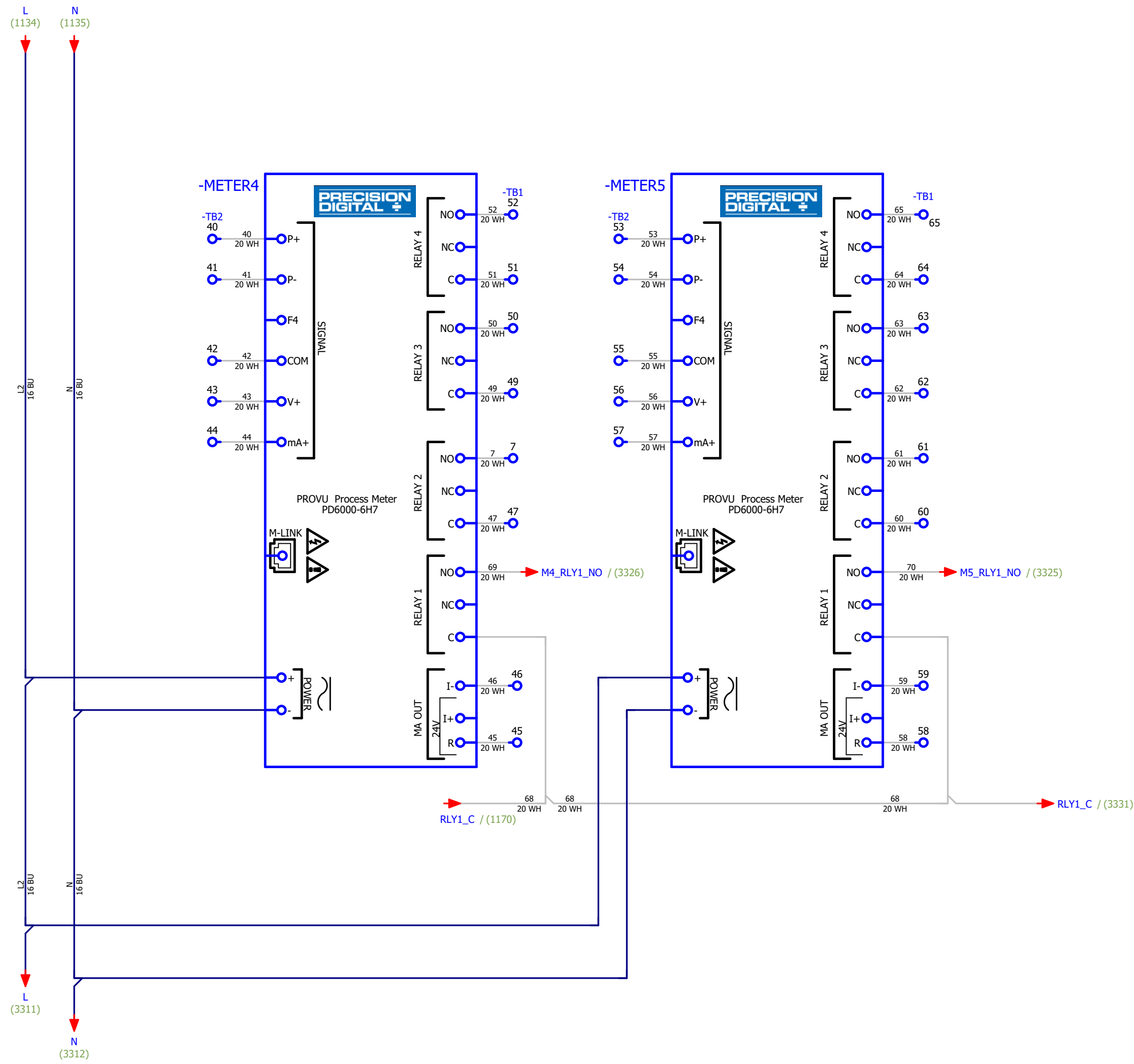

PANEL TO BEAR
UL508A LABEL

UL LISTED UL508A LISTED CONTROL PANEL

NOTE:
Specifications:
Class 1 Control Circuit
Incoming Power: 120 VAC 50/60 HZ, 5A
Fuse Spec: UL Listed 125/250 VAC 5A
Circuit Breaker Spec:
UL Listed 240 VAC/48 VDC, 10A, 1-pole, C curve

Installation Requirements:
Use only Copper Conductors rated 250V min, 60°C min.
Tighten Fuse Terminals to 7 in-lbs.
Tighten Circuit Breaker Terminals to 21 in-lbs.
Tighten GND and N Terminal Blocks to 4.4 in-lbs.
Tighten all other Field Terminals to 3.5 in-lbs.
Use conduit hubs or fittings with the same environmental rating as the enclosure.

Creation Date 04/13/26	Creator Name SLEONARD	<p>233 South Street Hopkinton, MA 01748 Phone: (508) 655-7300 www.predig.com</p>	Project Name PDEA-A5PVA6-PL-1F00RH-0-0	Project Description Process Value Alarm		Document Type Schematic multi-line	Section Page NO. 2 of 3	
Mod. Date 05/29/26	Mod. Name SLEONARD		Drawing Number DWG-PDEA-A5PVA6-PL-1F00RH-0-0	UL Requirement UL508A	Scale 2 : 3	Page Title: Internal Panel Wiring	Project Sheet NO. 4 of 12	REV. B

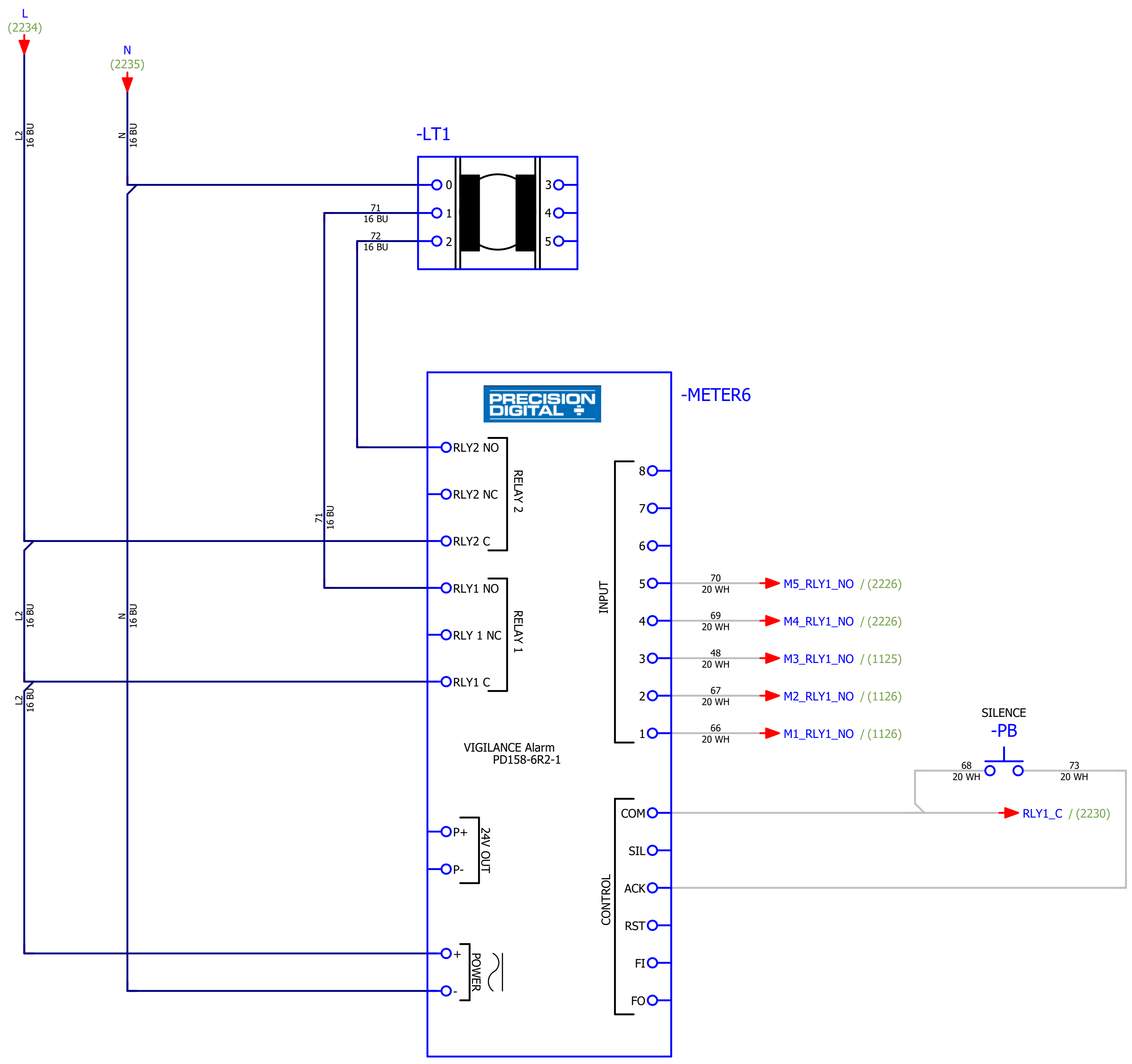

NOTES

1.) LT1 - 120VAC Light Stack Configuration

Pin 1 = Flashing Red Module
Pin 2 = Horn Module

PANEL TO BEAR
UL508A LABEL

UL LISTED UL508A LISTED CONTROL PANEL

NOTE:

Specifications:
Class 1 Control Circuit
Incoming Power: 120 VAC 50/60 HZ, 5A
Fuse Spec: UL Listed 125/250 VAC 5A
Circuit Breaker Spec:
UL Listed 240 VAC/48 VDC, 10A, 1-pole, C curve

Installation Requirements:
Use only Copper Conductors rated 250V min, 60°C min.
Tighten Fuse Terminals to 7 in-lbs.
Tighten Circuit Breaker Terminals to 21 in-lbs.
Tighten GND and N Terminal Blocks to 4.4 in-lbs.
Tighten all other Field Terminals to 3.5 in-lbs.
Use conduit hubs or fittings with the same environmental rating as the enclosure.

Creation Date 04/13/26	Creator Name SLEONARD	PRECISION DIGITAL	233 South Street Hopkinton, MA 01748 Phone: (508) 655-7300 www.predig.com	Project Name PDEA-A5PVA6-PL-1F00RH-0-0	Project Description Process Value Alarm		Document Type Schematic multi-line	Section Page NO. 3 of 3	
Mod. Date 05/29/26	Mod. Name SLEONARD		Drawing Number DWG-PDEA-A5PVA6-PL-1F00RH-0-0	UL Requirement UL508A	Scale 1 : 1	Page Title: Internal Panel Wiring	Project Sheet NO. 5 of 12	REV. B	

NOTES

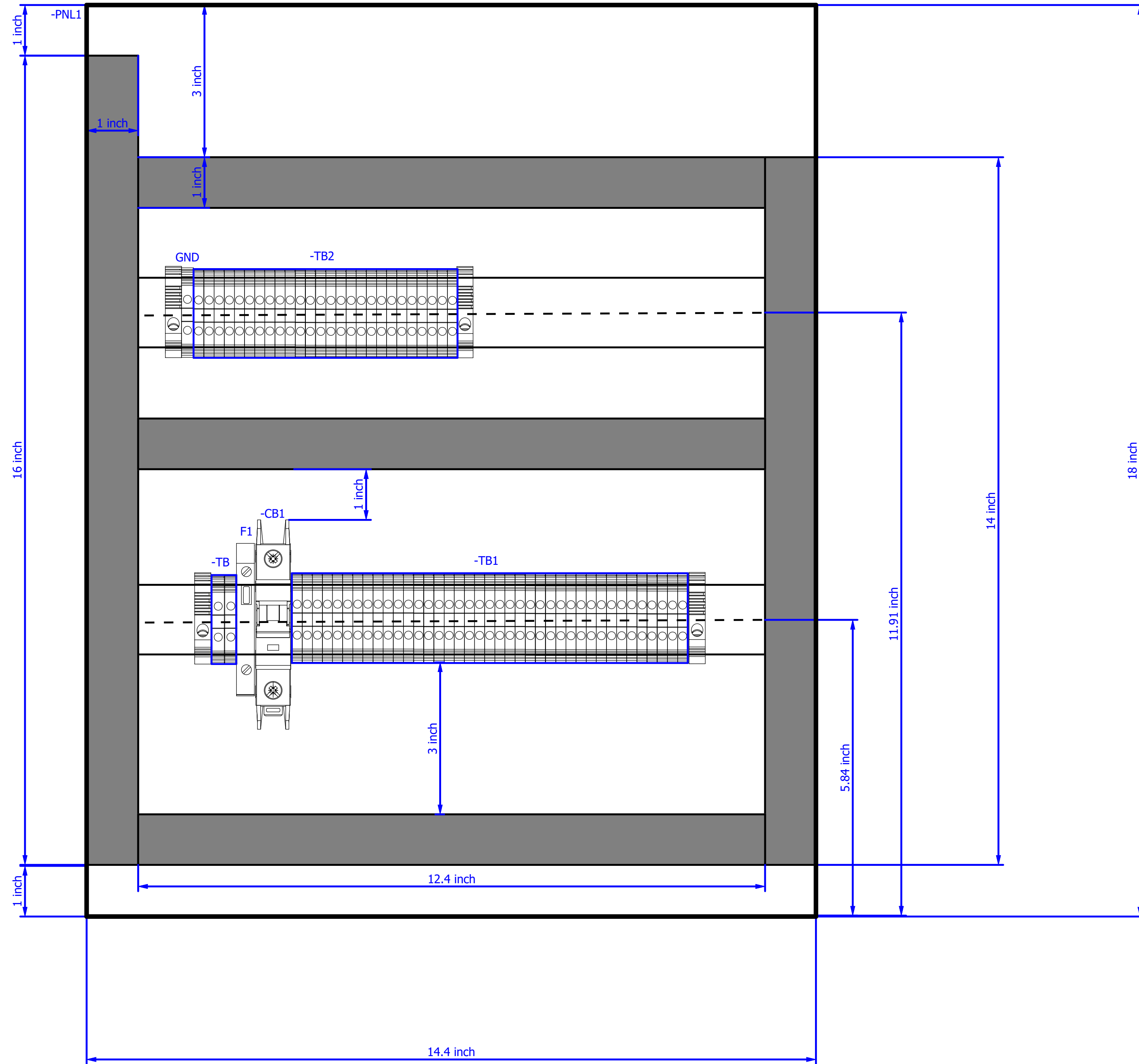

PANEL TO BEAR
UL508A LABEL

UL LISTED UL508A LISTED CONTROL PANEL

NOTE:
Specifications:
Class 1 Control Circuit
Incoming Power: 120 VAC 50/60 HZ, 5A
Fuse Spec: UL Listed 125/250 VAC 5A
Circuit Breaker Spec:
UL Listed 240 VAC/48 VDC, 10A, 1-pole, C curve

Installation Requirements:
Use only Copper Conductors rated 250V min, 60°C min.
Tighten Fuse Terminals to 7 in-lbs.
Tighten Circuit Breaker Terminals to 21 in-lbs.
Tighten GND and N Terminal Blocks to 4.4 in-lbs.
Tighten all other Field Terminals to 3.5 in-lbs.
Use conduit hubs or fittings with the same environmental rating as the enclosure.

Creation Date	Creator Name
04/13/26	SLEONARD
Mod. Date	Mod. Name
05/29/26	SLEONARD



233 South Street
Hopkinton, MA 01748
Phone: (508) 655-7300
www.predig.com

Project Name	PDEA-A5PVA6-PL-1F00RH-0-0
Drawing Number	DWG-PDEA-A5PVA6-PL-1F00RH-0-0

Project Description	Process Value Alarm
UL Requirement	UL508A

Document Type	Panel layout
Scale	2 : 3
Page Title:	Subpanel Layout

Section Page NO.	1 of 2
Project Sheet NO.	6 of 12
REV.	B

NOTES

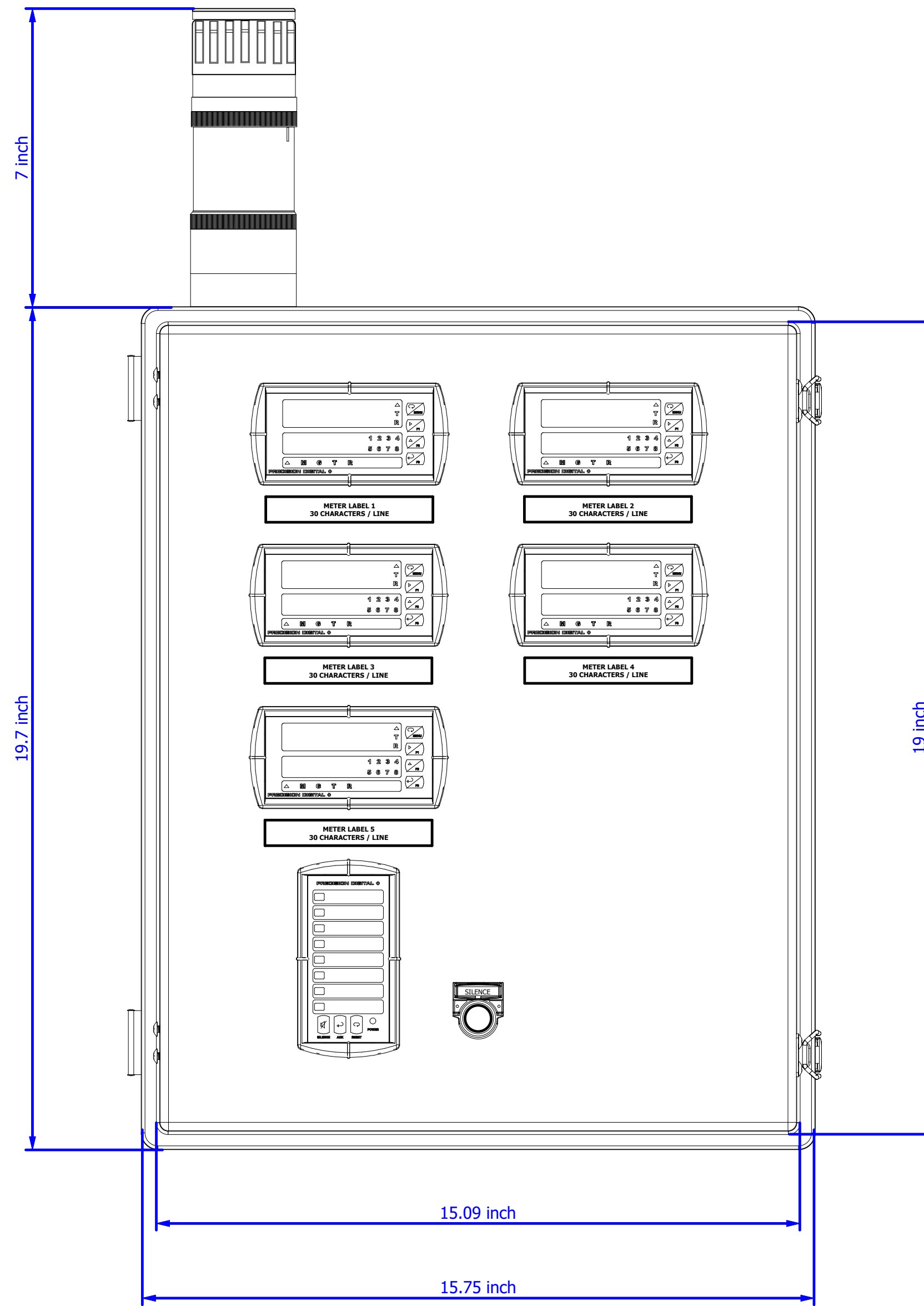
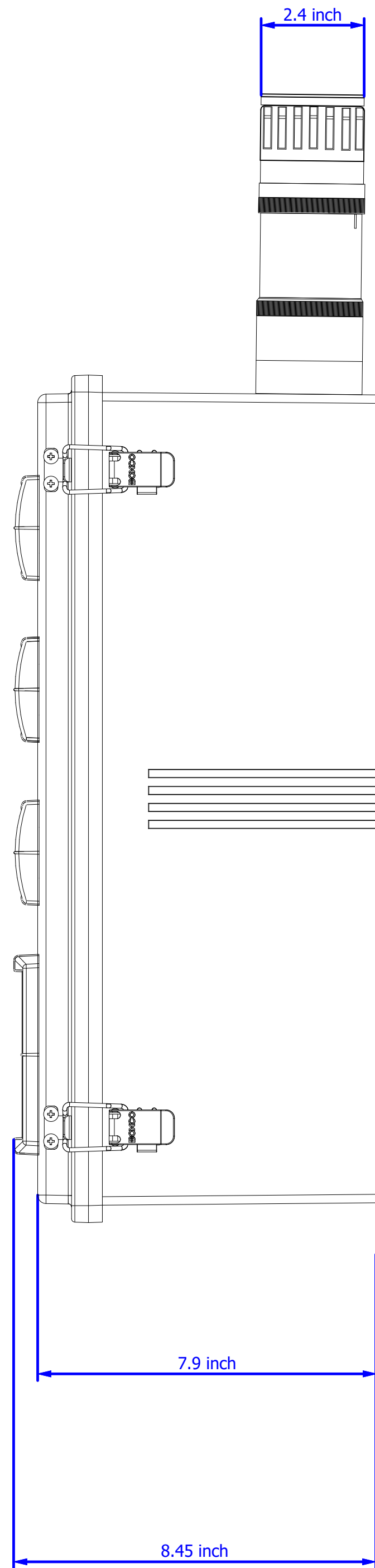

PANEL TO BEAR
UL508A LABEL

UL LISTED UL508A LISTED CONTROL PANEL

NOTE:
 Specifications:
 Class 1 Control Circuit
 Incoming Power: 120 VAC 50/60 HZ, 5A
 Fuse Spec: UL Listed 125/250 VAC 5A
 Circuit Breaker Spec:
 UL Listed 240 VAC/48 VDC, 10A, 1-pole, C curve

Installation Requirements:
 Use only Copper Conductors rated 250V min,
 60°C min.
 Tighten Fuse Terminals to 7 in-lbs.
 Tighten Circuit Breaker Terminals to 21 in-lbs.
 Tighten GND and N Terminal Blocks to 4.4 in-lbs.
 Tighten all other Field Terminals to 3.5 in-lbs.
 Use conduit hubs or fittings with the same
 environmental rating as the enclosure.

Creation Date	Creator Name
04/13/26	SLEONARD
Mod. Date	Mod. Name
06/12/26	SLEONARD



233 South Street
 Hopkinton, MA 01748
 Phone: (508) 655-7300
www.predig.com

Project Name	PDEA-A5PVA6-PL-1F00RH-0-0
Drawing Number	DWG-PDEA-A5PVA6-PL-1F00RH-0-0

Project Description	Process Value Alarm
UL Requirement	UL508A
Scale	2 : 5

Document Type	Panel layout
Page Title:	External Enclosure Layout

















Section Page NO.	2 of 2
Project Sheet NO.	7 of 12
REV.	B

Summarized Parts List

Precision Digital Corporation

233 South Street

Hopkinton MA, 01748









Part Number	Quantity	Description	Manufacturer	Document	Picture	Pos.
PD6000-6H7	5	SunBright ProVu Process Meter (85-265 VAC / 90-265 VDC) Input: (1) 0-20 mA, 4-20 mA, 0-5 V, 1-5 V, and ±10 V Outputs: 4 Relays with Interlocking Capability & (1) 24VDC 4-20mA Signal	Precision Digital			1
PD158-6R2-1	1	Vigilante II 1/8 DIN Alarm Annunciator UL Type 4X 85-265 VAC, 90-265 VDC Outputs: 24 VDC @ 200 mA & (2) Relays	Precision Digital			2
PDA2310	1	UL Type / NEMA 4X Enclosure Plastic 15.8" by 19.7" by 7.9" (WxHxD)	Precision Digital			3
PDP2310	1	14.4" x 18" Plastic Subpanel	Precision Digital			4
	1	YDE Piezo buzzer module 120VAC UL 4/4X/13; 90 dB 90dB	Auer Signal			5
	1	YDA LED RD flashing beacon module 120VAC UL 4/4X/13 ECO60	Auer Signal			6
	1	YMS Base for horizontal mounting UL 4/4X/13	Auer Signal			7
PDC-ENC-LBL	1	Engraved General Enclosure Label	Precision Digital			8
PDC-METER-LBL	5	Engraved Panel Meter Label	Precision Digital			9

Summarized Parts List

Precision Digital Corporation

233 South Street

Hopkinton MA, 01748















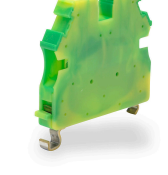

Part Number	Quantity	Description	Manufacturer	Document	Picture	Pos.
	1	22 mm Black Flush Momentary Black Bezel Pushbutton NEMA 4X	BACO Controls			10
	1	22 mm Plastic Anti-Rotation Ring Button/Switch Accessory	BACO Controls			11
	1	22 mm Black Standard Silence Legend Plate Plastic Insert Button/Switch Accessory	BACO Controls			12
	1	3 Position Clip Button/Switch Accessory	BACO Controls			13
	1	1 Normally Open (NO) Screw Terminal Contact Block Button/Switch Accessory	BACO Controls			14
	1	Miniature circuit breaker (MCB), C10/1 pole, NA, labelling	Eaton			15
	1	High voltage 1/4" x 1-1/4" time delay ceramic fuse 500 Vac/250 Vdc Current Rating 5A	Eaton			16
	1	4 sq.mm Fuse Terminal Blocks 35mm DIN Rail Mount Compatible with MDP series fuses	Connectwell Industries			17
	1	End Plate in Grey colour	Connectwell Industries			18

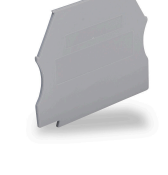
Summarized Parts List

Precision Digital Corporation

233 South Street

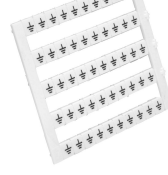
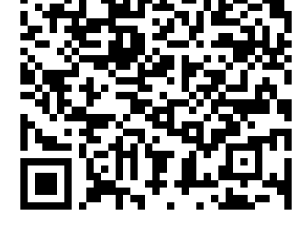
Hopkinton MA, 01748















Part Number	Quantity	Description	Manufacturer	Document	Picture	Pos.
	66	1" of Cable duct 25 x 40 25 x 40 mm	Phoenix Contact			19
	1	Screw single-level feedthrough terminal block, accepts wire size 26-10 AWG 30A, 35mm DIN rail mount 100kA SCCR w/ correct line side OCP	KONNECT-IT			20
	65	Screw single-level feedthrough terminal block, accepts wire size 26-12 AWG 20A, 35mm DIN rail mount 100kA SCCR w/ correct line side OCP	KONNECT-IT			21
	2	Screw grounding terminal block, accepts wire size 26-10 AWG Green and yellow, 35mm DIN rail mount	KONNECT-IT			22
	2	Single Terminal Block End Cap	KONNECT-IT			23
	1	Terminal Marking Tag 1-50	KONNECT-IT			24
	1	Terminal Marking Tag "L"	KONNECT-IT			25
	1	Terminal Marking Tag "GND"	KONNECT-IT			26
	1	Terminal Marking Tag "N"	KONNECT-IT			27

Summarized Parts List

Precision Digital Corporation

233 South Street

Hopkinton MA, 01748



Part Number	Quantity	Description	Manufacturer	Document	Picture	Pos.
	4	Screw-down end bracket 8mm Wide	KONNECT-IT			28
	1	Laser Label, 1.5" x 3.375"	Precision Digital			29
	1	Poly Adhesive Pocket	Precision Digital			30
	1	UL Enclosure ICP CULUS Label	Precision Digital			31
	1	Demo "PDC" Faceplate Label	Precision Digital			32
	1	Vinyl Label 1.5" X 3.375"	Precision Digital			33
	194	Wire Label 13 X 19	Precision Digital			34
	2310	1" of 20 AWG Hook-Up Wire 10/30 White 600V	Alpha Wire			35
	1000	1" of 16 AWG Hook-Up Wire 26/30 Blue 600V	Alpha Wire			36

Summarized Parts List

Precision Digital Corporation

233 South Street

Hopkinton MA, 01748

Part Number	Quantity	Description	Manufacturer	Document	Picture	Pos.
	1	8" DIN rail	Precision Digital			37

Creation Date 04/13/26	Creator Name SLEONARD	Specifications: UL508A LISTED CONTROL PANEL Class 1 Control Circuit Incoming Power: 120 VAC 50/60 HZ, 5A Fuse Spec: UL Listed 125/250 VAC 5A Circuit Breaker Spec: UL Listed 240 VAC/48 VDC, 10A, 1-pole, C curve	Installation Requirements: Use only Copper Conductors rated 250V min, 60°C min. Tighten Fuse Terminals to 7 in.-lbs. Tighten Circuit Breaker Terminals to 21 in.-lbs. Tighten GND and N Terminal Blocks to 4.4 in.-lbs. Tighten all other Field Terminals to 3.5 in.-lbs. Use conduit hubs or fittings with the same environmental rating as the enclosure.	Notes:			233 South Street Hopkinton, MA 01748 Phone: (508) 655-7300 www.predig.com	Project Name PDEA-A5PVA6-PL-1F00RH-0-0	Project Description Process Value Alarm	Document Type Summarized parts list	Section Page NO. 5 of 5		
Mod. Date 05/29/26	Mod. Name SLEONARD							Drawing Number DWG-PDEA-A5PVA6-PL-1F00RH-0-0	UL Requirement UL508A	Scale 1 : 1	Page Title: Summarized Parts List	Project Sheet NO. 12 of 12	REV. B