



Precision Digital Corporation

233 South Street  
 Hopkinton MA 01748  
 Phone (508) 655 - 7300  
 Email sales@predig.com



www.predig.com

Part Number

PDEA-A4PVA6-PL-1FGYRH-0-R

SAMPLE

Manufacturer

Precision Digital Corporation

Feed-In Voltage

120VAC

Project Description

Process Value Alarm

Control Voltage

120VAC

Type

Standard Product

Environmental Rating

UL Type 4X

Regulation

UL508A

Short Circuit Current Rating

N/A

Created on 04/13/26

Edit date 05/29/26

by: SLEONARD

Number of pages 11

<b>Creation Date</b> 04/13/26	<b>Creator Name</b> SLEONARD	<b>Specifications:</b> UL508A LISTED CONTROL PANEL Class 1 Control Circuit Incoming Power: 120 VAC 50/60 HZ, 5A Fuse Spec: UL Listed 125/250 VAC 5A Circuit Breaker Spec: UL Listed 240 VAC/48 VDC, 10A, 1-pole, C curve	<b>Installation Requirements:</b> Use only Copper Conductors rated 250V min, 60°C min. Tighten Fuse Terminals to 7 in-lbs. Tighten Circuit Breaker Terminals to 21 in-lbs. Tighten GND and N Terminal Blocks to 4.4 in-lbs. Tighten all other Field Terminals to 3.5 in-lbs. Use conduit hubs or fittings with the same environmental rating as the enclosure.	<b>Notes:</b>		<b>Project Name</b> PDEA-A4PVA6-PL-1FGYRH-0-R  233 South Street Hopkinton, MA 01748 Phone: (508) 655-7300 <a href="http://www.predig.com">www.predig.com</a>	<b>Project Description</b> Process Value Alarm	<b>Document Type</b> Title page / cover sheet	<b>Section Page NO.</b> 1 of 2		
<b>Mod. Date</b> 05/29/26	<b>Mod. Name</b> SLEONARD					<b>Drawing Number</b> DWG-PDEA-A4PVA6-PL-1FGYRH-0-R	<b>UL Requirement</b> UL508A	<b>Scale</b> 1 : 1	<b>Page Title:</b> Title Page	<b>Project Sheet NO.</b> 1 of 11	<b>REV.</b> B

# Table of Contents

Precision Digital Corporation

233 South Street  
Hopkinton MA, 01748

Page	Page Description	Date	Edited By
1	Title Page	05/29/26	SLEONARD
2	Table of Contents	05/29/26	SLEONARD
<b>Electrical Schematic</b>			
3	Internal Panel Wiring	05/29/26	SLEONARD
4	Internal Panel Wiring	05/29/26	SLEONARD
<b>Panel Layout</b>			
5	Subpanel Layout	05/29/26	SLEONARD
6	External Enclosure Layout	05/29/26	SLEONARD
<b>Bill of Materials</b>			
7	Summarized Parts List	05/29/26	SLEONARD
8	Summarized Parts List	05/29/26	SLEONARD
9	Summarized Parts List	05/29/26	SLEONARD
10	Summarized Parts List	05/29/26	SLEONARD
11	Summarized Parts List	05/29/26	SLEONARD

SAMPLE

<b>Creation Date</b> 04/13/26	<b>Creator Name</b> SLEONARD	<b>Specifications:</b> UL508A LISTED CONTROL PANEL Class 1 Control Circuit Incoming Power: 120 VAC 50/60 HZ, 5A Fuse Spec: UL Listed 125/250 VAC 5A Circuit Breaker Spec: UL Listed 240 VAC/48 VDC, 10A, 1-pole, C curve	<b>Installation Requirements:</b> Use only Copper Conductors rated 250V min, 60°C min. Tighten Fuse Terminals to 7 in-lbs. Tighten Circuit Breaker Terminals to 21 in-lbs. Tighten GND and N Terminal Blocks to 4.4 in-lbs. Tighten all other Field Terminals to 3.5 in-lbs. Use conduit hubs or fittings with the same environmental rating as the enclosure.	<b>Notes:</b>		<b>Project Name</b> PDEA-A4PVA6-PL-1FGYRH-0-R	<b>Project Description</b> Process Value Alarm	<b>Document Type</b> Table of contents	<b>Section Page NO.</b> 2 of 2	
<b>Mod. Date</b> 05/29/26	<b>Mod. Name</b> SLEONARD					<b>Drawing Number</b> DWG-PDEA-A4PVA6-PL-1FGYRH-0-R	<b>UL Requirement</b> UL508A	<b>Scale</b> 1 : 1	<b>Page Title:</b> Table of Contents	<b>Project Sheet NO.</b> 2 of 11

109  
110  
111  
112  
113  
114  
115  
116  
117  
118  
119  
120  
121  
122  
123  
124  
125  
126  
127  
128  
129  
130  
131  
132  
133  
134  
135  
136  
137  
138  
139

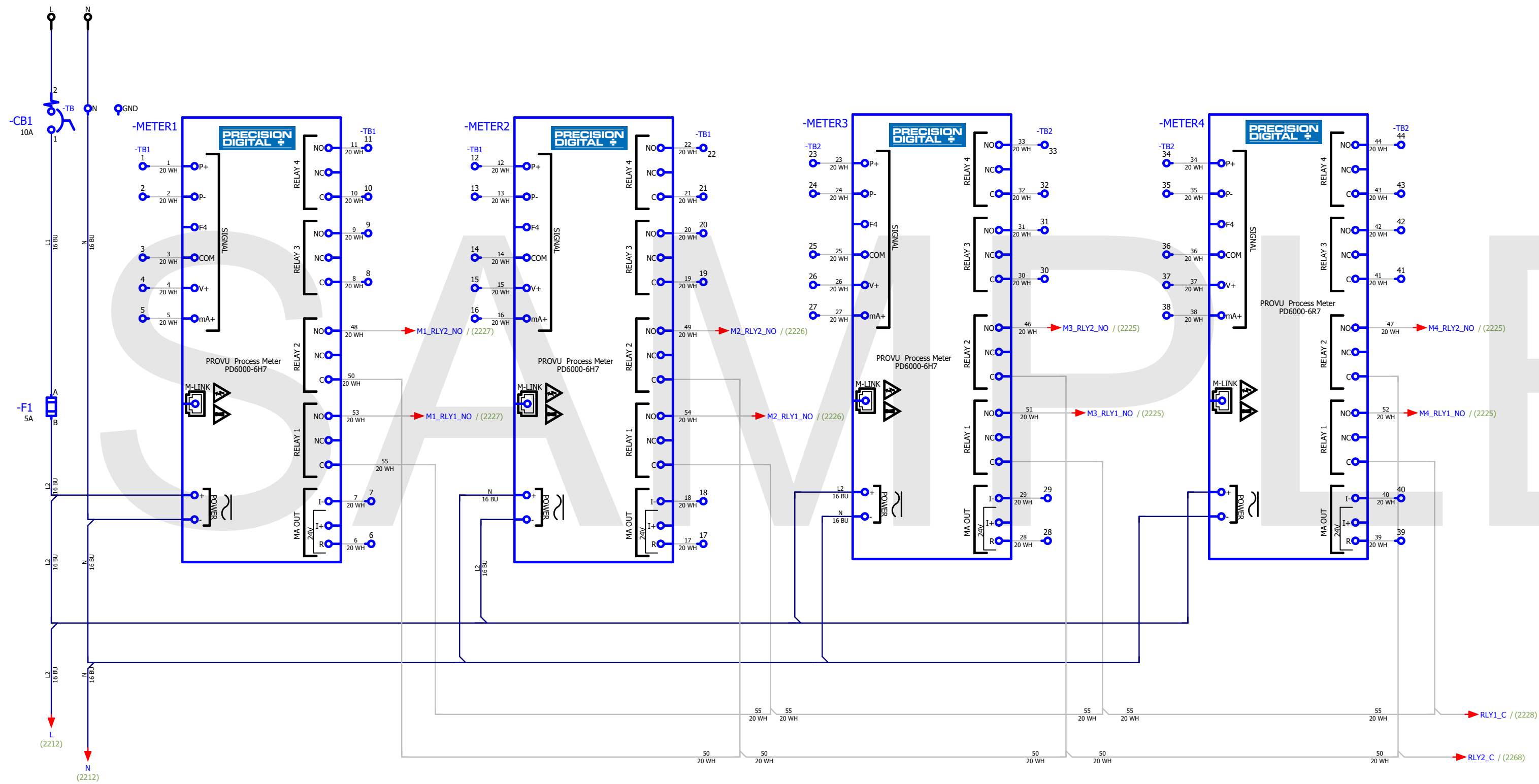

PANEL TO BEAR  
UL508A LABEL

**UL LISTED** UL508A LISTED CONTROL PANEL

NOTE:  
Specifications:  
Class 1 Control Circuit  
Incoming Power: 120 VAC 50/60 HZ, 5A  
Fuse Spec: UL Listed 125/250 VAC 5A  
Circuit Breaker Spec:  
UL Listed 240 VAC/48 VDC, 10A, 1-pole, C curve

Installation Requirements:  
Use only Copper Conductors rated 250V min, 60°C min.  
Tighten Fuse Terminals to 7 in-lbs.  
Tighten Circuit Breaker Terminals to 21 in-lbs.  
Tighten all other Field Terminals to 3.5 in-lbs.  
Use conduit hubs or fittings with the same environmental rating as the enclosure.

<b>Creation Date</b> 04/13/26	<b>Creator Name</b> SLEONARD		<b>Project Name</b> PDEA-A4PVA6-PL-1FGYRH-0-R	<b>Project Description</b> Process Value Alarm		<b>Document Type</b> Schematic multi-line	<b>Section Page NO.</b> 1 of 2	
<b>Mod. Date</b> 05/29/26	<b>Mod. Name</b> SLEONARD		<b>Drawing Number</b> DWG-PDEA-A4PVA6-PL-1FGYRH-0-R	<b>UL Requirement</b> UL508A	<b>Scale</b> 1 : 2	<b>Page Title:</b> Internal Panel Wiring	<b>Project Sheet NO.</b> 3 of 11	<b>REV.</b> B
233 South Street Hopkinton, MA 01748 Phone: (508) 655-7300 www.predig.com								

**NOTES**

1.) LT1 - 120VAC Light Stack Configuration

- Pin 1 = Flashing Green Module
- Pin 2 = Flashing Yellow Module
- Pin 3 = Flashing Red Module
- Pin 4 = Horn Module

**PANEL TO BEAR  
UL508A LABEL**

**UL LISTED** UL508A LISTED CONTROL PANEL

**NOTE:**  
 Specifications:  
 Class 1 Control Circuit  
 Incoming Power: 120 VAC 50/60 HZ, 5A  
 Fuse Spec: UL Listed 125/250 VAC 5A  
 Circuit Breaker Spec:  
 UL Listed 240 VAC/48 VDC, 10A, 1-pole, C curve

**Installation Requirements:**  
 Use only Copper Conductors rated 250V min, 60°C min.  
 Tighten Fuse Terminals to 7 in.-lbs.  
 Tighten Circuit Breaker Terminals to 21 in.-lbs.  
 Tighten GND and N Terminal Blocks to 4.4 in.-lbs.  
 Tighten all other Field Terminals to 3.5 in.-lbs.  
 Use conduit hubs or fittings with the same environmental rating as the enclosure.

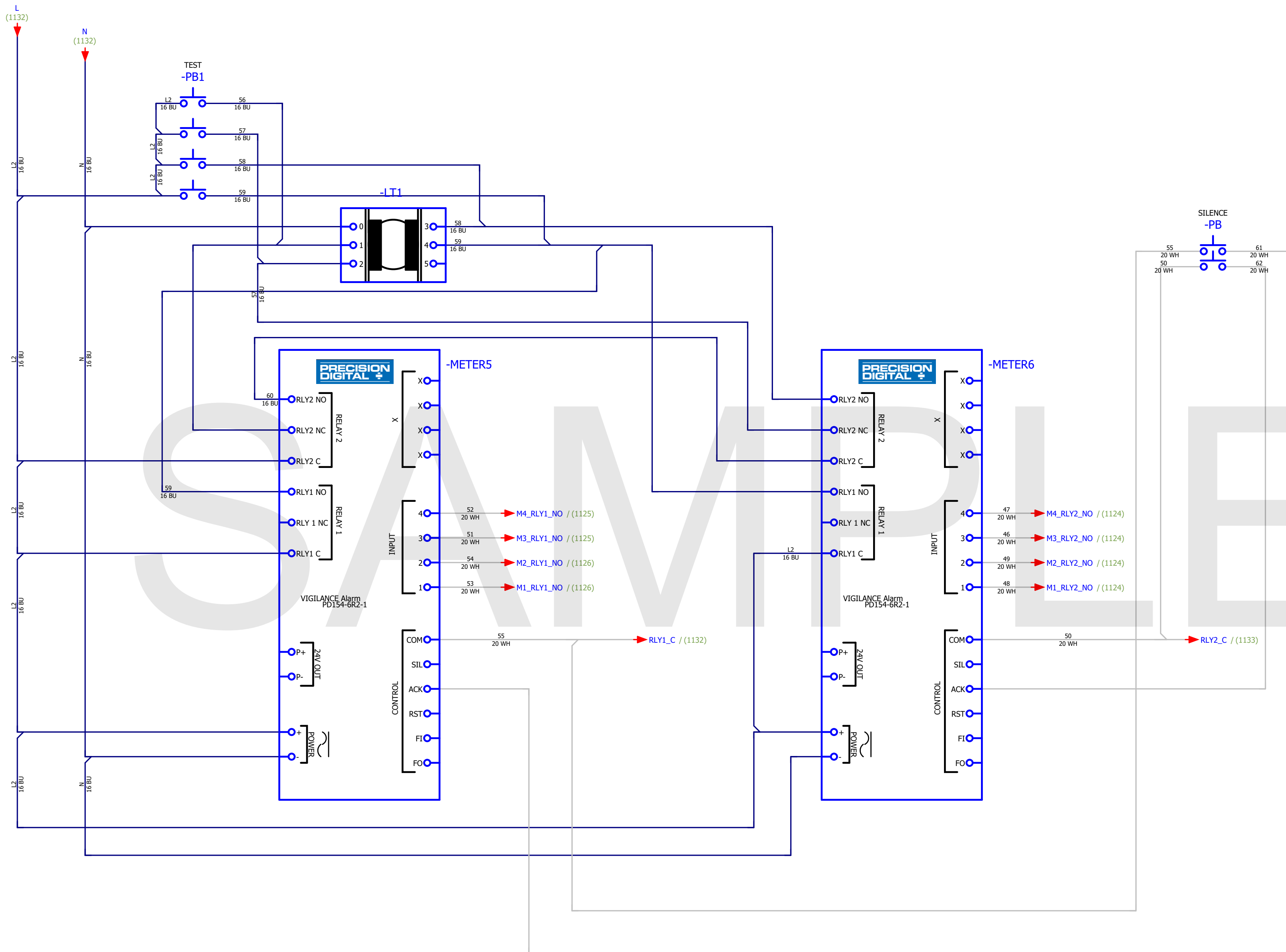

209  
210  
211  
212  
213  
214  
215  
216  
217  
218  
219  
220  
221  
222  
223  
224  
225  
226  
227  
228  
229  
230  
231  
232  
233  
234  
235  
236  
237  
238  
239

<b>Creation Date</b> 04/13/26	<b>Creator Name</b> SLEONARD		<b>Project Name</b> PDEA-A4PVA6-PL-1FGYRH-0-R	<b>Project Description</b> Process Value Alarm		<b>Document Type</b> Schematic multi-line		<b>Section Page NO.</b> 2 of 2		
<b>Mod. Date</b> 05/29/26	<b>Mod. Name</b> SLEONARD		<b>Project Name</b> 233 South Street Hopkinton, MA 01748 Phone: (508) 655-7300 www.predig.com	<b>Drawing Number</b> DWG-PDEA-A4PVA6-PL-1FGYRH-0-R	<b>UL Requirement</b> UL508A	<b>Scale</b> 2 : 3	<b>Page Title:</b> Internal Panel Wiring		<b>Project Sheet NO.</b> 4 of 11	<b>REV.</b> B

NOTES

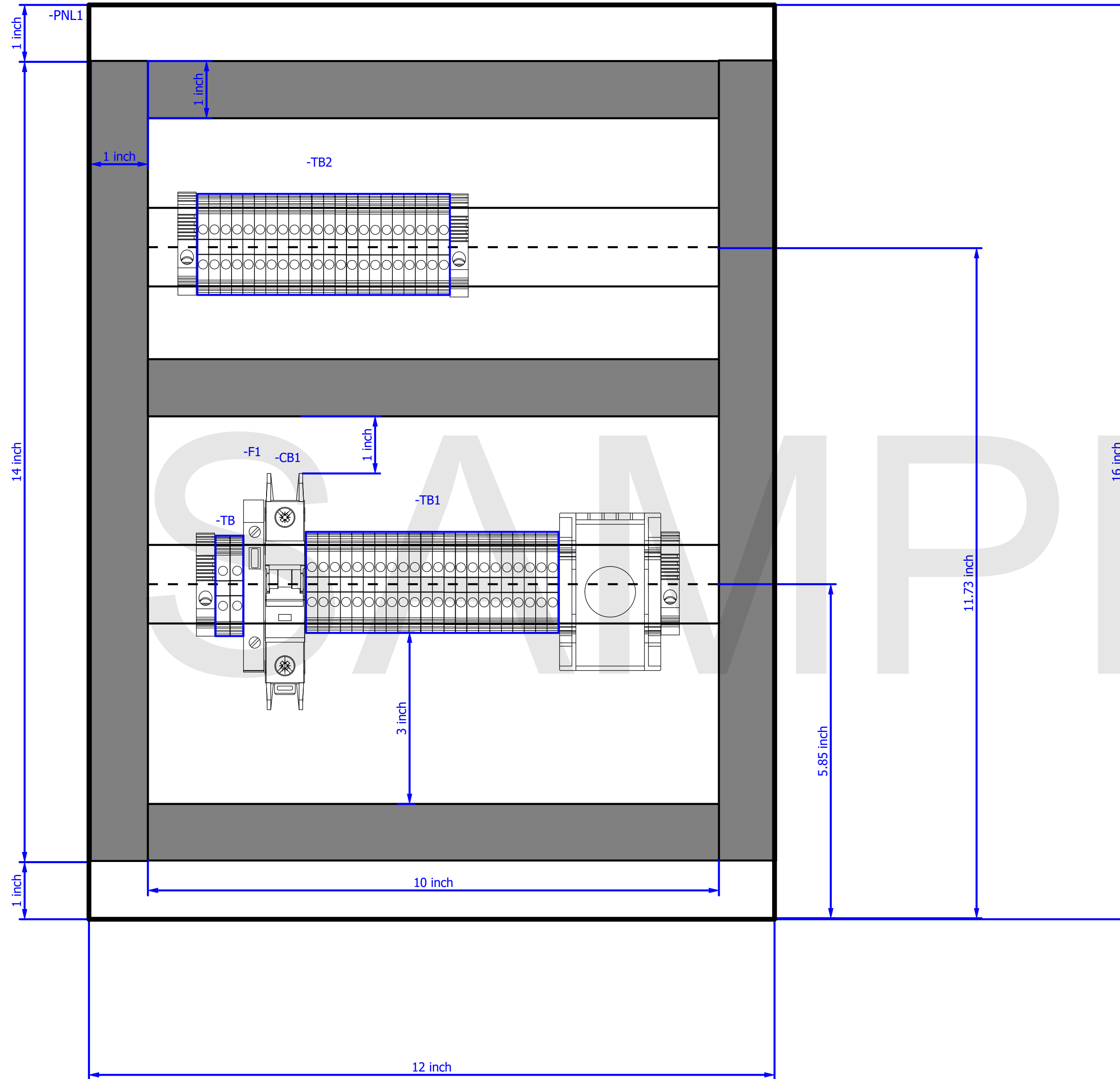

PANEL TO BEAR  
UL508A LABEL

**UL LISTED** UL508A LISTED CONTROL PANEL

**NOTE:**  
 Specifications:  
 Class 1 Control Circuit  
 Incoming Power: 120 VAC 50/60 HZ, 5A  
 Fuse Spec: UL Listed 125/250 VAC 5A  
 Circuit Breaker Spec:  
 UL Listed 240 VAC/48 VDC, 10A, 1-pole, C curve

**Installation Requirements:**  
 Use only Copper Conductors rated 250V min, 60°C min.  
 Tighten Fuse Terminals to 7 in-lbs.  
 Tighten Circuit Breaker Terminals to 21 in-lbs.  
 Tighten GND and N Terminal Blocks to 4.4 in-lbs.  
 Tighten all other Field Terminals to 3.5 in-lbs.  
 Use conduit hubs or fittings with the same environmental rating as the enclosure.

<b>Creation Date</b>	<b>Creator Name</b>
04/13/26	SLEONARD
<b>Mod. Date</b>	<b>Mod. Name</b>
05/29/26	SLEONARD



233 South Street  
 Hopkinton, MA 01748  
 Phone: (508) 655-7300  
 www.predig.com

<b>Project Name</b>	PDEA-A4PVA6-PL-1FGYRH-0-R
<b>Drawing Number</b>	DWG-PDEA-A4PVA6-PL-1FGYRH-0-R

<b>Project Description</b>	Process Value Alarm
<b>UL Requirement</b>	UL508A

<b>Document Type</b>	Panel layout
<b>Page Title:</b>	Subpanel Layout

<b>Section Page NO.</b>	1 of 2
<b>Project Sheet NO.</b>	5 of 11
<b>REV.</b>	B

NOTES

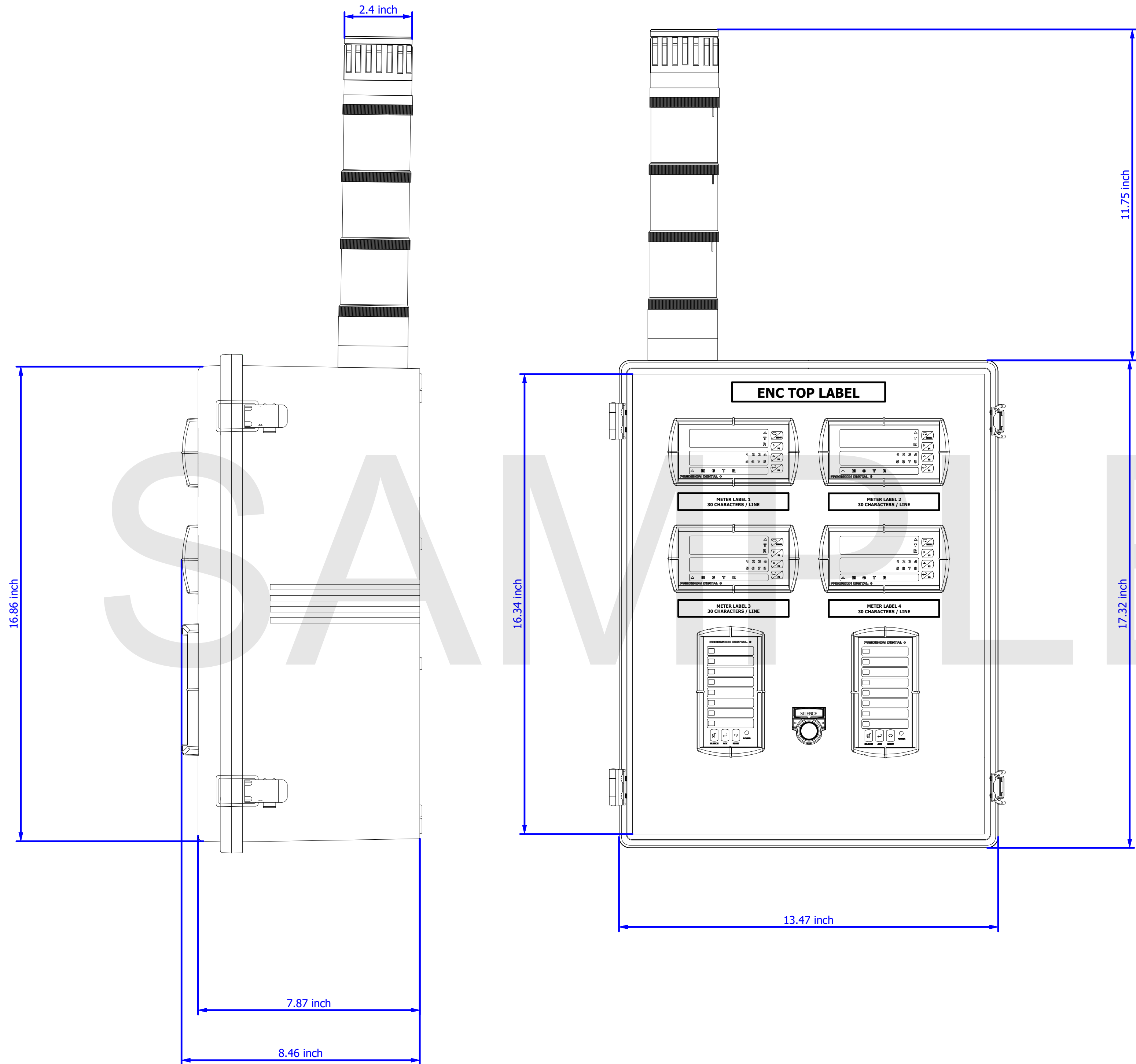

PANEL TO BEAR  
UL508A LABEL

**UL LISTED** UL508A LISTED CONTROL PANEL

NOTE:  
Specifications:  
Class 1 Control Circuit  
Incoming Power: 120 VAC 50/60 HZ, 5A  
Fuse Spec: UL Listed 125/250 VAC 5A  
Circuit Breaker Spec:  
UL Listed 240 VAC/48 VDC, 10A, 1-pole, C curve

Installation Requirements:  
Use only Copper Conductors rated 250V min, 60°C min.  
Tighten Fuse Terminals to 7 in-lbs.  
Tighten Circuit Breaker Terminals to 21 in-lbs.  
Tighten GND and N Terminal Blocks to 4.4 in-lbs.  
Tighten all other Field Terminals to 3.5 in-lbs.  
Use conduit hubs or fittings with the same environmental rating as the enclosure.

Creation Date	Creator Name
04/13/26	SLEONARD
Mod. Date	Mod. Name
05/29/26	SLEONARD



233 South Street  
Hopkinton, MA 01748  
Phone: (508) 655-7300  
www.predig.com

Project Name	Project Description
PDEA-A4PVA6-PL-1FGYRH-0-R	Process Value Alarm
Drawing Number	UL Requirement
DWG-PDEA-A4PVA6-PL-1FGYRH-0-R	UL508A

Document Type	Scale
Panel layout	2 : 5
Page Title:	Section Page NO.
External Enclosure Layout	2 of 2

Project Sheet NO.	REV.
6 of 11	B

# Summarized Parts List

Precision Digital Corporation

233 South Street

Hopkinton MA, 01748













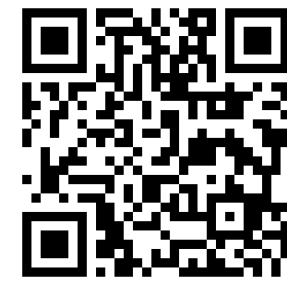





Part Number	Quantity	Description	Manufacturer	Document	Picture	Pos.
PD6000-6H7	4	SunBright ProVu Process Meter (85-265 VAC / 90-265 VDC) Input: (1) 0-20 mA, 4-20 mA, 0-5 V, 1-5 V, and ±10 V Outputs: 4 Relays with Interlocking Capability & (1) 24VDC 4-20mA Signal	Precision Digital			1
PD154-6R2-1	2	Vigilante II 1/8 DIN Alarm Annunciator UL Type 4X 85-265 VAC, 90-265 VDC Outputs: 24 VDC @ 200 mA & (2) Relays	Precision Digital			2
PDP1939	1	12.0" by 16.0" Plastic Subplate Compatible with PDA1939	Precision Digital			3
PDA1939	1	Plastic UL Type 4X Enclosure 13.8" x 17.7" x 7.9" (350 mm x 450 mm x 200 mm) (W x H x D)	Precision Digital			4
	1	YDE Piezo buzzer module 120VAC UL 4/4X/13; 90 dB 90dB	Auer Signal			5
	1	YDA LED RD flashing beacon module 120VAC UL 4/4X/13 ECO60	Auer Signal			6
	1	YDA LED YE flashing beacon module 120VAC UL 4/4X/13 ECO60	Auer Signal			7
	1	YDA LED GRN Steady beacon module 120VAC UL 4/4X/13 ECO60	Auer Signal			8
	1	YMS Base for horizontal mounting UL 4/4X/13	Auer Signal			9

# Summarized Parts List

Precision Digital Corporation

233 South Street

Hopkinton MA, 01748

Part Number	Quantity	Description	Manufacturer	Document	Picture	Pos.
PDC-ENC-LBL	1	Engraved General Enclosure Label	Precision Digital			10
PDC-METER-LBL	4	Engraved Panel Meter Label	Precision Digital			11
	2	22 mm Black Flush Momentary Black Bezel Pushbutton NEMA 4X	BACO Controls			12
	2	22 mm Plastic Anti-Rotation Ring Button/Switch Accessory	BACO Controls			13
	1	22 mm Black Standard Silence Legend Plate Plastic Insert Button/Switch Accessory	BACO Controls			14
	1	22 mm Black Standard Test Legend Plate Plastic Insert Button/Switch Accessory	BACO Controls			15
	1	Push button adapter for DIN rail mounting	Siemens			16
	2	3 Position Clip Button/Switch Accessory	BACO Controls			17
	6	1 Normally Open (NO) Screw Terminal Contact Block Button/Switch Accessory	BACO Controls			18

<b>Creation Date</b> 04/13/26	<b>Creator Name</b> SLEONARD	<b>Specifications:</b> UL508A LISTED CONTROL PANEL Class 1 Control Circuit Incoming Power: 120 VAC 50/60 HZ, 5A Fuse Spec: UL Listed 125/250 VAC 5A Circuit Breaker Spec: UL Listed 240 VAC/48 VDC, 10A, 1-pole, C curve	<b>Installation Requirements:</b> Use only Copper Conductors rated 250V min, 60°C min. Tighten Fuse Terminals to 7 in.-lbs. Tighten Circuit Breaker Terminals to 21 in.-lbs. Tighten GND and N Terminal Blocks to 4.4 in.-lbs. Tighten all other Field Terminals to 3.5 in.-lbs. Use conduit hubs or fittings with the same environmental rating as the enclosure.	<b>Notes:</b>
<b>Mod. Date</b> 05/29/26	<b>Mod. Name</b> SLEONARD			



233 South Street  
Hopkinton, MA 01748  
Phone: (508) 655-7300  
[www.predig.com](http://www.predig.com)

<b>Project Name</b> PDEA-A4PVA6-PL-1FGYRH-0-R	<b>Project Description</b> Process Value Alarm
<b>Drawing Number</b> DWG-PDEA-A4PVA6-PL-1FGYRH-0-R	<b>UL Requirement</b> UL508A















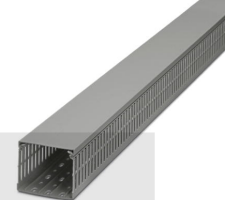

<b>Document Type</b> Summarized parts list	<b>Scale</b> 1 : 1
<b>Page Title:</b> Summarized Parts List	

<b>Section Page NO.</b> 2 of 5	<b>Project Sheet NO.</b> 8 of 11	<b>REV.</b> B
-----------------------------------	-------------------------------------	------------------

# Summarized Parts List

Precision Digital Corporation

233 South Street  
Hopkinton MA, 01748

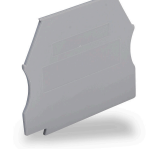













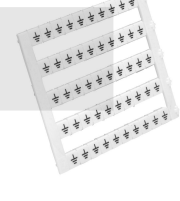

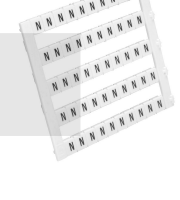
Part Number	Quantity	Description	Manufacturer	Document	Picture	Pos.
	1	Miniature circuit breaker (MCB), C10/1 pole, NA, labelling	Eaton			19
	1	High voltage 1/4" x 1-1/4" time delay ceramic fuse 500 Vac/250 Vdc Current Rating 5A	Eaton			20
	1	4 sq.mm Fuse Terminal Blocks 35mm DIN Rail Mount Compatible with MDP series fuses	Connectwell Industries			21
	1	End Plate in Grey colour	Connectwell Industries			22
	58	1" of Cable duct 25 x 40 25 x 40 mm	Phoenix Contact			23
	1	Screw single-level feedthrough terminal block, accepts wire size 26-10 AWG 30A, 35mm DIN rail mount 100kA SCCR w/ correct line side OCP	KONNECT-IT			24
	44	Screw single-level feedthrough terminal block, accepts wire size 26-12 AWG 20A, 35mm DIN rail mount 100kA SCCR w/ correct line side OCP	KONNECT-IT			25
	1	Screw grounding terminal block, accepts wire size 26-10 AWG Green and yellow, 35mm DIN rail mount	KONNECT-IT			26
	2	Single Terminal Block End Cap	KONNECT-IT			27

# Summarized Parts List

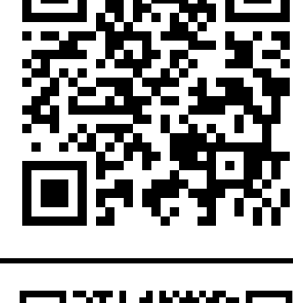
Precision Digital Corporation

233 South Street

Hopkinton MA, 01748

Part Number	Quantity	Description	Manufacturer	Document	Picture	Pos.
	1	Terminal Marking Tag 1-50	KONNECT-IT			28
	1	Terminal Marking Tag "L"	KONNECT-IT			29
	1	Terminal Marking Tag "GND"	KONNECT-IT			30
	1	Terminal Marking Tag "N"	KONNECT-IT			31
	2	Screw-down end bracket 8mm Wide	KONNECT-IT			32
	1	Laser Label, 1.5" x 3.375"	Precision Digital			33
	1	Poly Adhesive Pocket	Precision Digital			34
	1	UL Enclosure ICP CULUS Label	Precision Digital			35
	1	Demo "PDC" Faceplate Label	Precision Digital			36









SAMPLE

# Summarized Parts List

Precision Digital Corporation

233 South Street

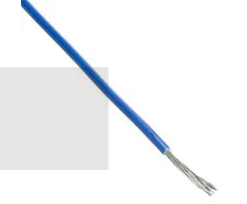
Hopkinton MA, 01748

Part Number	Quantity	Description	Manufacturer	Document	Picture	Pos.
	1	Vinyl Label 1.5" X 3.375"	Precision Digital			37
	104	Wire Label 13 X 19	Precision Digital			38
	1470	1" of 20 AWG Hook-Up Wire 10/30 White 600V	Alpha Wire			39
	150	1" of 16 AWG Hook-Up Wire 26/30 Blue 600V	Alpha Wire			40
	1	8" DIN rail	Precision Digital			41

SAMPLE

<b>Creation Date</b> 04/13/26	<b>Creator Name</b> SLEONARD	<b>Specifications:</b> UL508A LISTED CONTROL PANEL Class 1 Control Circuit Incoming Power: 120 VAC 50/60 HZ, 5A Fuse Spec: UL Listed 125/250 VAC 5A Circuit Breaker Spec: UL Listed 240 VAC/48 VDC, 10A, 1-pole, C curve	<b>Installation Requirements:</b> Use only Copper Conductors rated 250V min, 60°C min. Tighten Fuse Terminals to 7 in.-lbs. Tighten Circuit Breaker Terminals to 21 in.-lbs. Tighten GND and N Terminal Blocks to 4.4 in.-lbs. Tighten all other Field Terminals to 3.5 in.-lbs. Use conduit hubs or fittings with the same environmental rating as the enclosure.	<b>Notes:</b>			233 South Street Hopkinton, MA 01748 Phone: (508) 655-7300 <a href="http://www.predig.com">www.predig.com</a>	<b>Project Name</b> PDEA-A4PVA6-PL-1FGYRH-0-R	<b>Project Description</b> Process Value Alarm	<b>Document Type</b> Summarized parts list	<b>Section Page NO.</b> 5 of 5		
<b>Mod. Date</b> 05/29/26	<b>Mod. Name</b> SLEONARD							<b>Drawing Number</b> DWG-PDEA-A4PVA6-PL-1FGYRH-0-R	<b>UL Requirement</b> UL508A	<b>Scale</b> 1 : 1	<b>Page Title:</b> Summarized Parts List	<b>Project Sheet NO.</b> 11 of 11	<b>REV.</b> B