

PDA2300 Economical Plastic NEMA 4X Enclosures

Data Sheet



Download free 3-D CAD files of these enclosures to simplify your drawings!

predig.com/documentation-cad

PDA2301 Enclosure Shown with a ProVu Meter and MOD-LH Light / Horn and Button.
Meter & MOD-LH Sold Separately. Assembly Required.



FEATURES

- House up to 10 Instruments
- Plastic
- Horizontal, Vertical or No Cutouts
- 1/4, 1/8, and 1/16 DIN Cutout(s) Pre-Cut
- NEMA 4X
- Hinged Door
- Stainless Steel Cover Latches
- Instruments Mounted in Cover
- Sub-Panels Available
- Mounting Hardware Provided
- PDA1024-01 24 VDC Power Supply Available
- UL Listed
- Light / Horn & Button

OVERVIEW

The PDA2300 series of economical plastic NEMA 4X enclosures for meters and controllers provides a convenient way to mount up to ten Precision Digital meters / controllers to walls and other vertical structures. Many of these enclosures also have room for additional devices like a light / horn and a 24 V transmitter power supply. Sub-panels are available to mount additional devices to the base of the enclosure. These enclosures come pre-cut with horizontal or vertical 1/4, 1/8, or 1/16 DIN cutouts, or they can be ordered with no cutouts. The instruments are mounted in the door of the enclosure thus allowing for programming and operation of the instrument. Mounting hardware is provided. The door is hinged and secured with stainless steel latches. Enclosures, meters/controllers and accessories are ordered and packaged separately.

WALL MOUNTING

The PDA2300 enclosures include four mounting flanges and four screws for your convenience. Using the included screws and a phillips head screwdriver simply assemble each flange in the four threaded screw holes on the back of the enclosure as shown in the example below. Now the enclosure is ready to be easily mounted to a wall.

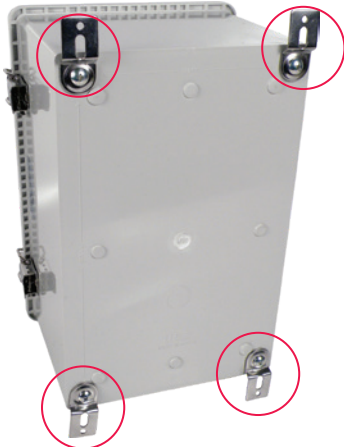

The PDA2301 series enclosures with supplied mounting flanges installed



The PDA2300 series enclosures is supplied with 4 screws and 4 mounting flanges

COVER SECURING METHOD

The cover is secured using stainless steel clasps.



ENCLOSURE SELECTION UTILITY

This utility simplifies the selection process of the right enclosure for your application based on the number and type of instruments to be installed in the enclosure. Below is a step-by-step overview of how this utility works.

STEP 1. Select number of instruments

Select the total number of instruments to be installed in the enclosure from the drop down menu.

STEP 2. Select cutout configuration

Select the cutout configuration desired for the enclosure. Choose from horizontal, vertical, or dual configurations as shown in the examples below for a 4 cutouts configuration.

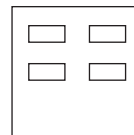

4 Horizontal

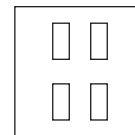

4 Vertical

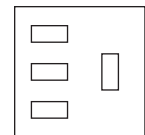

3 Horizontal
1 Vertical

STEP 3. Select type of instruments

Select the type of instrument(s) that will be installed into the enclosure. Below is an overview of the types of instruments supported.



For more information about instrument types see the enclosure Specifications or hover over an image while using the Enclosure Selection Utility.

STEP 4. Choose enclosure from results

SKU	Description	Stock	Lead Time	Price
PDA2304	PDA2300 Series NEMA 4X Plastic Enclosures Enclosure Cutouts: Four (4) Material: Plastic Meter Mounting: Through front panel Orientation: Horizontal Warranty: 1 year Approvals: UL/C-UL	3	3 business days	\$269.00
PDA2504	PDA2500 Series Plastic NEMA 4X Enclosures Enclosure Cutouts: Four (4) DIN Size: 1/8 DIN Material: Plastic Meter Mounting: Through front panel Orientation: Horizontal Warranty: 1 year Approvals: UL/C-UL	1	13 business days	\$349.00
PDA2604	PDA2600 Series Stainless Steel NEMA 4X Enclosures Enclosure Cutouts: Four (4) Material: Stainless Steel Meter Mounting: Through front panel	1	33 business days	\$859.00



Need help selecting the right enclosure?
www.predig.com/esu

MODELS AVAILABLE

1/8 DIN Horizontal Cutouts



PDA2301



PDA2302



PDA2303



PDA2304



PDA2304-1



PDA2304-2



PDA2304-3



PDA2305



PDA2306



PDA2307



PDA2308



PDA2309



PDA2310



PDA2312



Need help selecting the right enclosure?
Go to www.predig.com/esu

MODELS AVAILABLE (CONTINUED)

1/8 DIN Vertical Cutouts



PDA2301-V



PDA2302-V



PDA2303-V



PDA2304-V



PDA2305-V



PDA2306-V



PDA2322

1/4 DIN Cutouts



PDA2301-4



PDA2302-4



PDA2301-16



PDA2302-16

1/16 DIN Cutouts

No Cutouts



PDA2303-B



PDA2308-B



PDA2310-B

ACCESSORIES



Sub-Panels

The PDP2303, PDP2308, PDP2310 sub-panels provide a convenient way to mount additional items to the base of the enclosure. They can be drilled to accept screws for easy mounting of relays, contactors, securing wiring clips, or installing other internal devices. See chart on the right for compatibility.

Sub-Panel Specifications

Size:

- PDP2303: 10.5" x 6.5"
(266 mm x 166 mm)
- PDP2308: 14.4" x 10.4"
(365 mm x 265 mm)
- PDP2310: 18.0" x 14.1"
(458 mm x 358 mm)

Material: ABS Plastic
Mounting hardware is included.

Model	PDP2303	PDP2308	PDP2310
1/8 DIN Horizontal Cutouts			
PDA2301	•		
PDA2302	•		
PDA2303	•		
PDA2304		•	
PDA2304-1		•	
PDA2304-2		•	
PDA2304-3		•	
PDA2305		•	
PDA2306		•	
PDA2307		•	
PDA2308		•	
PDA2309			•
PDA2310			•
PDA2312		•	
Vertical Cutouts			
PDA2301-V	•		
PDA2302-V	•		
PDA2303-V		•	
PDA2304-V		•	
PDA2305-V		•	
PDA2306-V		•	
PDA2322	•		

Model	PDP2303	PDP2308	PDP2310
1/4 DIN Cutouts			
PDA2301-4	•		
PDA2302-4	•		
1/16 DIN Cutouts			
PDA2301-16	•		
PDA2302-16	•		
No Cutouts			
PDA2303-B	•		
PDA2308-B		•	
PDA2310-B			•

ACCESSORIES (CONTINUED)



**PDA-SSTAG
Stainless Steel Tags**

PDA-SSTAG is a laser etched stainless steel tag accessory for any Precision Digital meters / controllers. The tag features custom text for equipment identification, instruction, or whatever else is needed in your facility. Each tag comes with a stainless steel wire and lead seal for easy mounting wherever you need it.



**PDA1024-01 24 VDC
Power Supply for DIN Rail**

The PDA1024-01 is a DIN rail mounted 24 VDC, 1.5 A power supply.

Specifications

Output Voltage: 21.6 ~ 26.4 VDC; ±10% 1.5A rated current.

Dimensions: 3.07" x 3.66" x 2.20"
(78 mm x 93 mm x 56 mm) (W x H x D)



**PDX18DIN-FILLER
1/8 DIN Cutout Filler**

The NEMA 4X 1/8 DIN cutout filler is used to cover up empty 1/8 DIN cutouts and maintain the NEMA 4X rating to the panel or enclosure. It consists of a generic bezel with a black faceplate, as well as mounting brackets, gasket, etc.



**PDA-BUTTON
Momentary Pushbutton**

The PDA-BUTTON Series are IP67 fully sealed momentary pushbuttons that can be used for a variety of applications, such as resetting the manually-resettable relays on various Precision Digital meters. They are available with red, black and green buttons.

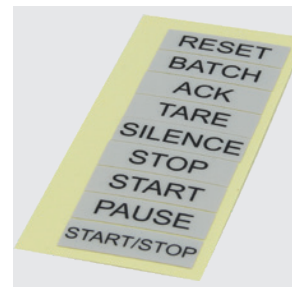

Button Labels

The button comes with 9 pre-printed message labels the user can affix under the button: RESET, BATCH, ACK, TARE, SILENCE, STOP, START, PAUSE, START/STOP.



**MOD-BUTTON
Pushbutton with Hole Drilled in Enclosure**

When this is ordered, the enclosure comes pre-drilled with a hole for pushbutton to be installed by user. Enclosure is sold separately. The pushbutton is centered on the cover of the enclosure about an inch off the bottom. For mounting in different locations, order items separately and drill holes and mount as desired. Other pushbutton colors are available.

ACCESSORIES (CONTINUED)

PDA2300 Series Enclosure with Light / Horn

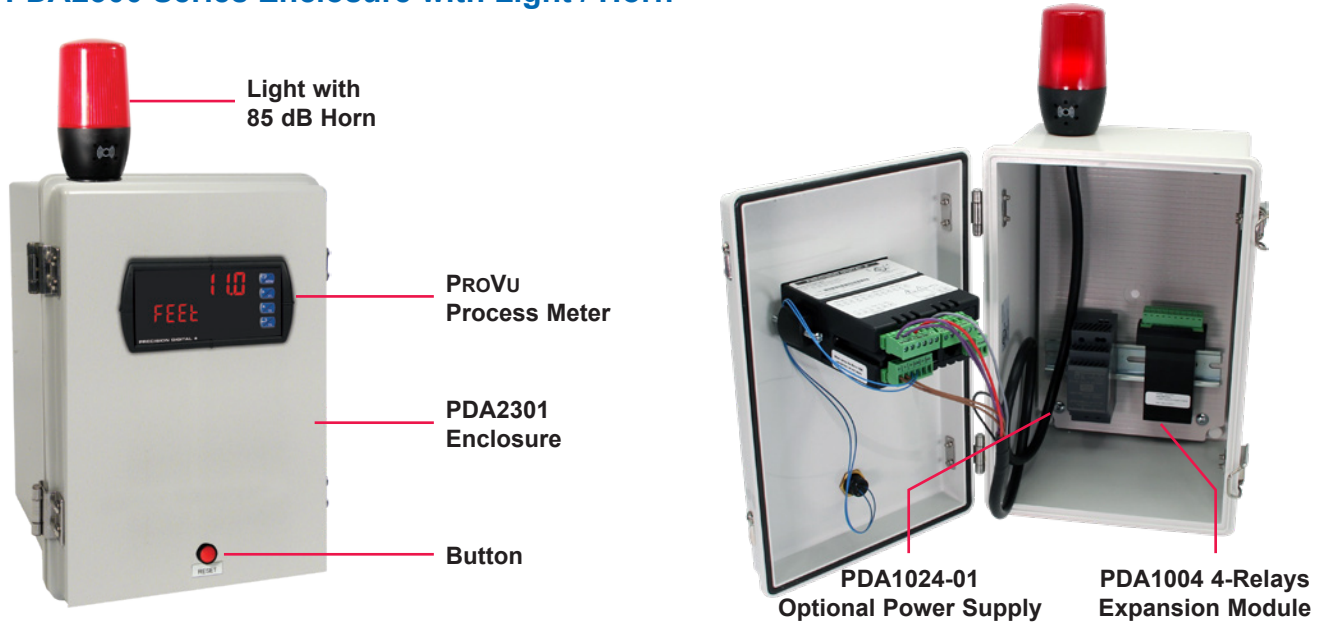

Light / Horn Accessories

Precision Digital offers a Light / Horn that can be mounted to any PDA2300 series enclosures by the user. This Light / Horn can be wired to flash or stay steady on and the horn is rated at 85 dB. The light and horn can be controlled independently of each other via separate relays on the meter / controller such that the horn can be programmed to silence via a button mounted to the enclosure and the light can be programmed to stay on until the alarm clears.

The light / horn and button are all rated NEMA 4X or IP65. The following table illustrates a typical way the Light / Horn accessory can be wired and programmed using the four relays on the PROVu meter:

Relay #	Connected to	Typical reset method (user selectable)
1	Flashing Light ⁽¹⁾	Auto reset
2	Horn	Silence with button at any time
3	User Device	As user desires
4	User Device	As user desires

1. Light can be wired to flash or stay steady on

Notes:

1. The Light / Horn accessory is powered from the 200 mA transmitter power supply; so when it is installed, there is less power available for the transmitter. See MOD-LH Series instruction manuals for details.

MOD-LH Light / Horn Accessory

When this is ordered, the enclosure comes pre-drilled with holes for the Light / Horn and Button to be installed by user. Meter / controller and enclosure are sold separately. The Light / Horn hole is in the back left corner of the enclosure and the button is centered on the cover of the enclosure about an inch off the bottom. For mounting in different locations, order items separately and drill holes and mount as desired. Other light and button colors are available.

Light / Horn Dimensions

Units: Inches (mm)

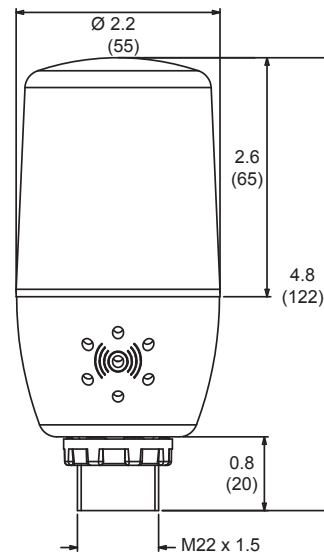

SPECIFICATIONS

General

Material: Thermoplastic Polyester
Color: Gray
Instruments: Houses up to 10 meters / controllers
Instrument Mounting Method: Through cover
Cover Mounting Method: Hinge / Latch
Ratings: NEMA 4X
Approvals: UL, C-UL
Operating Temperature: -40 to 120°C
Warranty: 1 year

Instrument Types

Type	Instruments
C	PD603, PD644, PD743, PD765, PD6602, PD6603, PD6604, PD6606, PD6607, PD6608, PD6622, PD6624, and PD6626, and PD6628.
D	PD138, PD154, PD158, and PD520
E	PD6000, PD6001, PD6060, PD6080, PD6081, PD6088, PD6089, PD6100, PD6200, PD6210, PD6262, PD6300, PD6310, PD6310-WM, PD6363, PD6400, and PD7000
F	PD530
G	PD510

Dimensions / Features

• Available ■ 1 Required

Model	# of Cutouts	Instrument Type					Outside Dimensions (H x W x D) Inch (mm)	Inside Dimensions (H x W x D) Inch (mm)	Mounting Dimensions Inch (mm)	Conduit Hole	Fits PDA1024-01	Fits Light / Horn	Weight lb (kg)
		C	D	E	F	G							
1/8 DIN Horizontal Cutouts													
PDA2301	1						11.8 x 7.9 x 7.0 (300 x 201 x 178)	11.0 x 7.0 x 6.9 (281 x 180 x 176)	9.96 x 7.72 (253 x 196)		•	•	3.15 (1.43)
PDA2302	2	•		•									
PDA2303	3												
PDA2304	4					15.75 x 11.8 x 7.0 (400 x 300 x 178)	15.0 x 11.0 x 6.9 (382 x 281 x 176)	13.90 x 11.65 (353 x 296)		•	•	5.50 (2.49)	
PDA2304-1	1												
PDA2304-2	2												
PDA2304-3	3												
PDA2305	5	•		•									
PDA2306	6												
PDA2307	7												
PDA2308	8												
PDA2312	2					19.7 x 15.8 x 7.9 (500 x 401 x 201)	18.7 x 14.8 x 7.0 (475 x 375 x 182)	17.80 x 15.59 (452 x 396)		•	•	8.75 (3.97)	
PDA2309	9	•		•									
PDA2310	10												
1/8 DIN Vertical Cutouts													
PDA2301-V	1					11.8 x 7.9 x 7.0 (300 x 201 x 178)	11.0 x 7.0 x 6.9 (281 x 180 x 176)	9.96 x 7.72 (253 x 196)		•	•	3.15 (1.43)	
PDA2302-V	2		•										
PDA2322	2	•	■	•		15.75 x 11.8 x 7.0 (400 x 300 x 178)	15.0 x 11.0 x 6.9 (382 x 281 x 176)	13.90 x 11.65 (353 x 296)		•	•	5.50 (2.49)	
PDA2303-V	3												
PDA2304-V	4												
PDA2305-V	5	•											
PDA2306-V	6												

SPECIFICATIONS (CONTINUED)

Dimensions / Features

Model	# of Cutouts	Instrument Type					Outside Dimensions (H x W x D) Inch (mm)	Inside Dimensions (H x W x D) Inch (mm)	Mounting Dimensions Inch (mm)	Conduit Hole	Fits PDA1024-01	Fits Light / Horn	Weight lb (kg)
		C	D	E	F	G							
1/4 and 1/16 DIN Cutouts													
PDA2301-4	1				•		11.8 x 7.9 x 7.0 (300 x 201 x 178)	11.0 x 7.0 x 6.9 (281 x 180 x 176)	9.96 x 7.72 (253 x 196)		•	•	3.15 (1.43)
PDA2302-4	2												
PDA2301-16	1				•								
PDA2302-16	2												
No Cutouts													
PDA2303-B	N/A						11.8 x 7.9 x 7.0 (300 x 201 x 178)	11.0 x 7.0 x 6.9 (281 x 180 x 176)	9.96 x 7.72 (253 x 196)		•	•	3.15 (1.43)
PDA2308-B	N/A						15.75 x 11.8 x 7.0 (400 x 300 x 178)	15.0 x 11.0 x 6.9 (382 x 281 x 176)	13.90 x 11.65 (353 x 296)		•	•	5.50 (2.49)
PDA2310-B	N/A						19.7 x 15.8 x 7.9 (500 x 401 x 201)	18.7 x 14.8 x 7.0 (475 x 375 x 182)	17.80 x 15.59 (452 x 396)		•	•	8.75 (3.97)

DIMENSIONS

Units: Inches (mm)

Small Enclosures

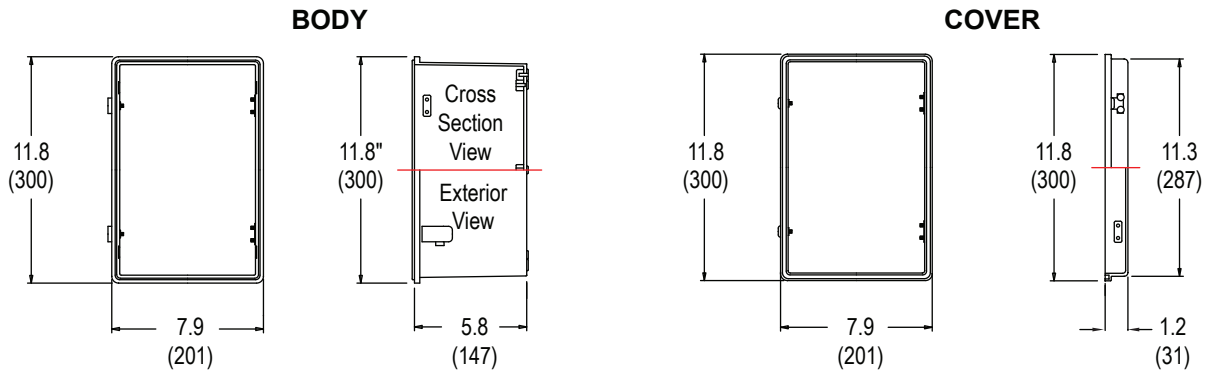

Dimensions for: PDA2301, PDA2301-4, PDA2301-16, PDA2301-V, PDA2302, PDA2302-4, PDA2302-16, PDA2302-V, PDA2303, PDA2303-B, PDA2322.

Medium Enclosures

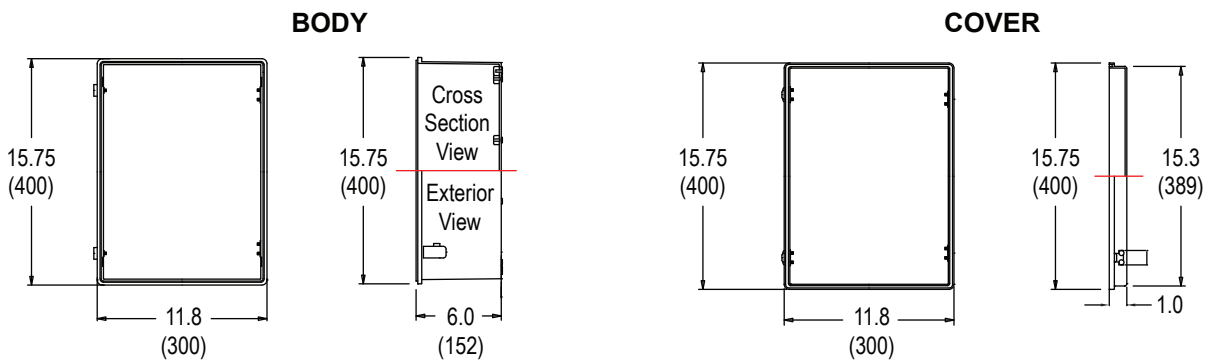

Dimensions for: PDA2303-V, PDA2304, PDA2304-V, PDA2304-1, PDA2304-2, PDA2304-3, PDA2305, PDA2305-V, PDA2306, PDA2306-V, PDA2307, PDA2308, PDA2308-B, PDA2312.

Large Enclosures

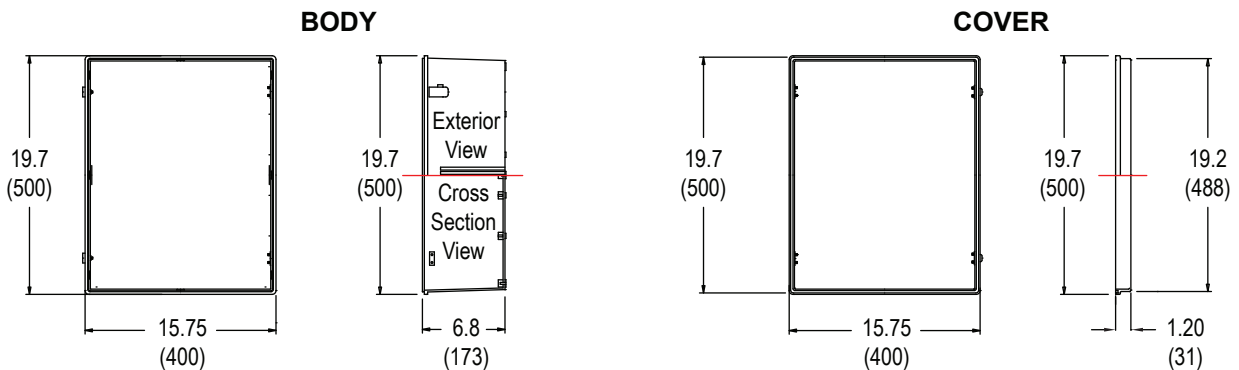

Dimensions for: PDA2309, PDA2310, PDA2310-B.



Download free 3-D CAD files of these enclosures to simplify your drawings!

predig.com/documentation-cad

ORDERING INFORMATION

1/8 DIN Horizontal Cutouts

Model	# of Cutouts	Instrument Type	
		C	E
PDA2301	1	•	•
PDA2302	2	•	•
PDA2303	3	•	•
PDA2304	4	•	•
PDA2304-1	1	•	•
PDA2304-2	2	•	•
PDA2304-3	3	•	•
PDA2305	5	•	•
PDA2306	6	•	•
PDA2307	7	•	•
PDA2308	8	•	•
PDA2309	9	•	•
PDA2310	10	•	•
PDA2312	2	•	•

1/8 DIN Vertical Cutouts

Model	# of Cutouts	Instrument Type		
		C	D	E
PDA2301-V	1		•	
PDA2302-V	2		•	
PDA2303-V	3		•	
PDA2304-V	4		•	
PDA2305-V	5		•	
PDA2306-V	6		•	
PDA2322	2	•	■	•

• Available ■ 1 Required

1/4 and 1/16 DIN Cutouts

Model	# of Cutouts	Instrument Type	
		F	G
PDA2301-4	1	•	
PDA2302-4	2	•	
PDA2301-16	1		•
PDA2302-16	2		•



WARNING

Cancer and Reproductive Harm - www.P65Warnings.ca.gov

Instrument Types

Type	Instruments
C	PD603, PD644, PD743, PD765, PD6602, PD6603, PD6604, PD6606, PD6607, PD6608, PD6622, PD6624, and PD6626, and PD6628.
D	PD138, PD154, PD158, and PD520
E	PD600, PD6001, PD6060, PD6080, PD6081, PD6088, PD6089, PD6100, PD6200, PD6210, PD6262, PD6300, PD6310, PD6310-WM, PD6363, PD6400, and PD7000
F	PD530
G	PD510

No Cutouts

Model	Description
PDA2303-B	Enclosure with no Cutouts
PDA2308-B	Enclosure with no Cutouts
PDA2310-B	Enclosure with no Cutouts

Sub-Panels

Model	Description
PDP2303	For PDA2301 - PDA2303 & PDA2322
PDP2308	For PDA2304 - PDA2308 & PDA2312
PDP2310	For PDA2309 & PDA2310

Accessories

Model	Description
MOD-LHRB1	Red ⁽³⁾ Light / Horn + Button with Holes Drilled ⁽¹⁾ in Enclosure
PDA-LHR	Red ⁽³⁾ Light / Horn
MOD-BUTTON1R-P	IP67 Red ⁽³⁾ Pushbutton ⁽²⁾ with Hole Drilled in Enclosure
PDA-BUTTON1R	Red ⁽³⁾ Button ⁽²⁾
PDA1002	6" DIN Rail Mounting Kit
PDA1024-01	24 VDC Power Supply for DIN Rail
PDA-SSTAG	Stainless Steel Tag
PDX18DIN-FILLER	1/8 DIN Cutout Filler

1. The enclosure comes pre-drilled with holes for Light / Horn and Button to be installed by user. Meter / controller and enclosure are sold separately. The Light / Horn hole is in the back left corner of the enclosure and the button is centered on the front of the enclosure about an inch off the bottom of the door. For mounting in different locations, order items separately and drill holes and mount as desired.
2. The Button works only with meters / controllers that have digital input contacts.
3. For other color options see corresponding instruction manual.

Disclaimer

The information contained in this document is subject to change without notice. Precision Digital Corporation makes no representations or warranties with respect to the contents hereof, and specifically disclaims any implied warranties of merchantability or fitness for a particular purpose.

©2023 Precision Digital Corporation. All rights reserved.

LDS2300_L 04/23